

2 TYPICAL DEMOLITION SECTION

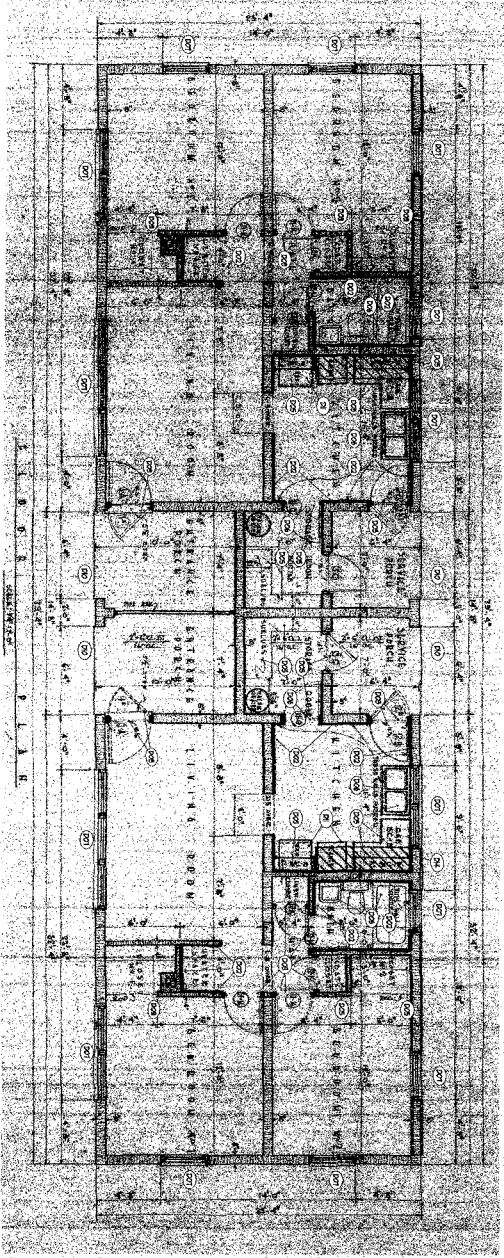

1 BUILDING B DEMO PLAN

6N GENERAL NOTES SCHEDULE

| NO. | DESCRIPTION |
|-----|---|
| 6N | DEMOLITION NOTES |
| 1 | REMOVE CONSTRUCTION OF ALL EXISTING... (text continues) |
| 2 | REMOVE CONSTRUCTION OF ALL EXISTING... (text continues) |
| 3 | REMOVE CONSTRUCTION OF ALL EXISTING... (text continues) |
| 4 | REMOVE CONSTRUCTION OF ALL EXISTING... (text continues) |
| 5 | REMOVE CONSTRUCTION OF ALL EXISTING... (text continues) |
| 6 | REMOVE CONSTRUCTION OF ALL EXISTING... (text continues) |
| 7 | REMOVE CONSTRUCTION OF ALL EXISTING... (text continues) |
| 8 | REMOVE CONSTRUCTION OF ALL EXISTING... (text continues) |
| 9 | REMOVE CONSTRUCTION OF ALL EXISTING... (text continues) |
| 10 | REMOVE CONSTRUCTION OF ALL EXISTING... (text continues) |
| 11 | REMOVE CONSTRUCTION OF ALL EXISTING... (text continues) |
| 12 | REMOVE CONSTRUCTION OF ALL EXISTING... (text continues) |
| 13 | REMOVE CONSTRUCTION OF ALL EXISTING... (text continues) |
| 14 | REMOVE CONSTRUCTION OF ALL EXISTING... (text continues) |
| 15 | REMOVE CONSTRUCTION OF ALL EXISTING... (text continues) |
| 16 | REMOVE CONSTRUCTION OF ALL EXISTING... (text continues) |
| 17 | REMOVE CONSTRUCTION OF ALL EXISTING... (text continues) |
| 18 | REMOVE CONSTRUCTION OF ALL EXISTING... (text continues) |
| 19 | REMOVE CONSTRUCTION OF ALL EXISTING... (text continues) |
| 20 | REMOVE CONSTRUCTION OF ALL EXISTING... (text continues) |
| 21 | REMOVE CONSTRUCTION OF ALL EXISTING... (text continues) |
| 22 | REMOVE CONSTRUCTION OF ALL EXISTING... (text continues) |
| 23 | REMOVE CONSTRUCTION OF ALL EXISTING... (text continues) |
| 24 | REMOVE CONSTRUCTION OF ALL EXISTING... (text continues) |
| 25 | REMOVE CONSTRUCTION OF ALL EXISTING... (text continues) |
| 26 | REMOVE CONSTRUCTION OF ALL EXISTING... (text continues) |

| MARK | DATE | REVISION |
|------|------|----------|
| | | |
| | | |
| | | |
| | | |

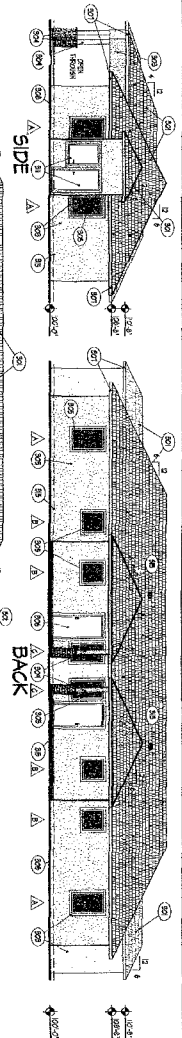

2 ELEVATIONS VERSION 1

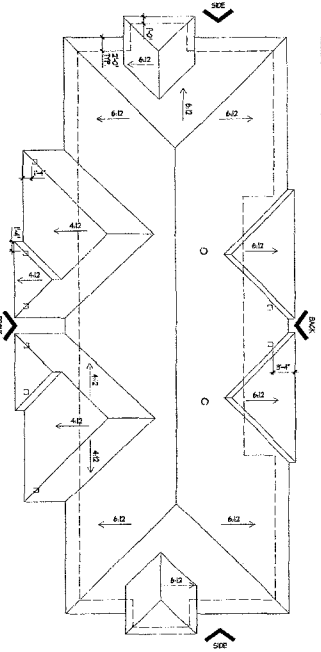

3 ROOF PLAN VERSION 1

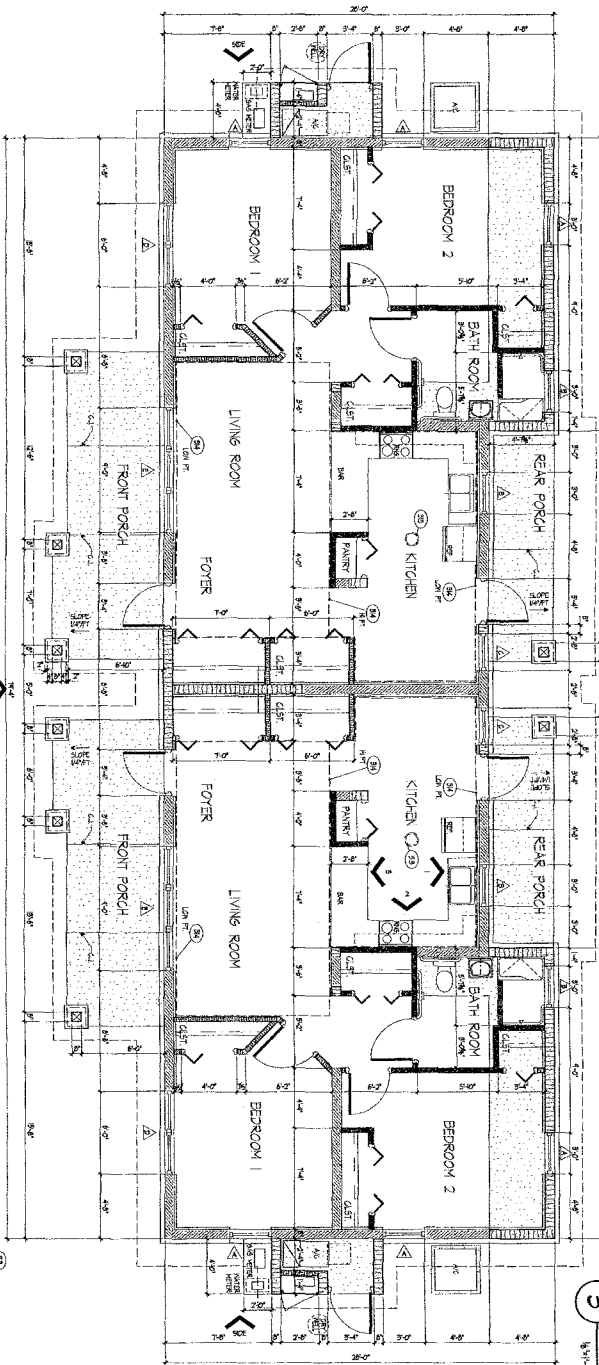

1 FLOOR PLAN

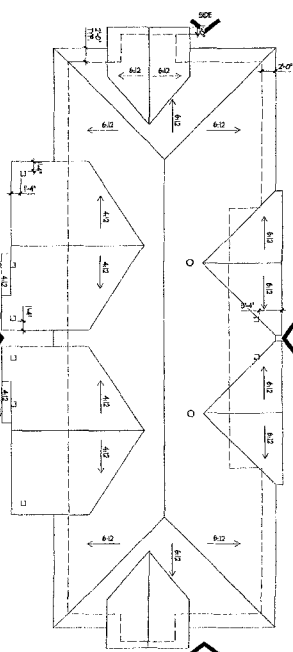

4 ROOF PLAN VERSION 2

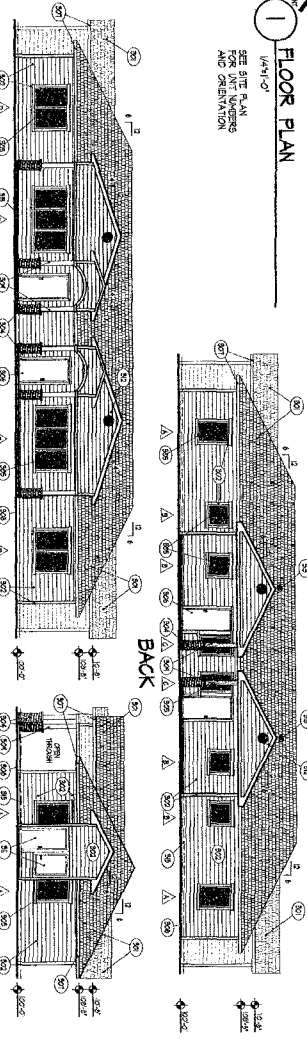

5 ELEVATIONS VERSION 2

| MATERIAL SCHEDULE | |
|-------------------|----------------------------------|
| M1 | WALL TYPES |
| 1 | 3 BRD SHIP WALL, 2" MIN. YR. |
| 2 | 2 BRD SHIP WALL, 1 1/2" MIN. YR. |
| 3 | 4 SHIP WALL, 1 1/2" MIN. YR. |
| 4 | 1/2" BRD AREA |
| 5 | SHIPING 2" DIA. |
| 6 | SHIPING 2" DIA. |
| 7 | SHIPING 2" DIA. |
| 8 | SHIPING 2" DIA. |
| 9 | SHIPING 2" DIA. |
| 10 | SHIPING 2" DIA. |
| 11 | SHIPING 2" DIA. |
| 12 | SHIPING 2" DIA. |
| 13 | SHIPING 2" DIA. |
| 14 | SHIPING 2" DIA. |
| 15 | SHIPING 2" DIA. |
| 16 | SHIPING 2" DIA. |
| 17 | SHIPING 2" DIA. |
| 18 | SHIPING 2" DIA. |
| 19 | SHIPING 2" DIA. |
| 20 | SHIPING 2" DIA. |
| 21 | SHIPING 2" DIA. |
| 22 | SHIPING 2" DIA. |
| 23 | SHIPING 2" DIA. |
| 24 | SHIPING 2" DIA. |
| 25 | SHIPING 2" DIA. |
| 26 | SHIPING 2" DIA. |
| 27 | SHIPING 2" DIA. |
| 28 | SHIPING 2" DIA. |
| 29 | SHIPING 2" DIA. |
| 30 | SHIPING 2" DIA. |
| 31 | SHIPING 2" DIA. |
| 32 | SHIPING 2" DIA. |
| 33 | SHIPING 2" DIA. |
| 34 | SHIPING 2" DIA. |
| 35 | SHIPING 2" DIA. |
| 36 | SHIPING 2" DIA. |
| 37 | SHIPING 2" DIA. |
| 38 | SHIPING 2" DIA. |
| 39 | SHIPING 2" DIA. |
| 40 | SHIPING 2" DIA. |
| 41 | SHIPING 2" DIA. |
| 42 | SHIPING 2" DIA. |
| 43 | SHIPING 2" DIA. |
| 44 | SHIPING 2" DIA. |
| 45 | SHIPING 2" DIA. |
| 46 | SHIPING 2" DIA. |
| 47 | SHIPING 2" DIA. |
| 48 | SHIPING 2" DIA. |
| 49 | SHIPING 2" DIA. |
| 50 | SHIPING 2" DIA. |
| 51 | SHIPING 2" DIA. |
| 52 | SHIPING 2" DIA. |
| 53 | SHIPING 2" DIA. |
| 54 | SHIPING 2" DIA. |
| 55 | SHIPING 2" DIA. |
| 56 | SHIPING 2" DIA. |
| 57 | SHIPING 2" DIA. |
| 58 | SHIPING 2" DIA. |
| 59 | SHIPING 2" DIA. |
| 60 | SHIPING 2" DIA. |
| 61 | SHIPING 2" DIA. |
| 62 | SHIPING 2" DIA. |
| 63 | SHIPING 2" DIA. |
| 64 | SHIPING 2" DIA. |
| 65 | SHIPING 2" DIA. |
| 66 | SHIPING 2" DIA. |
| 67 | SHIPING 2" DIA. |
| 68 | SHIPING 2" DIA. |
| 69 | SHIPING 2" DIA. |
| 70 | SHIPING 2" DIA. |
| 71 | SHIPING 2" DIA. |
| 72 | SHIPING 2" DIA. |
| 73 | SHIPING 2" DIA. |
| 74 | SHIPING 2" DIA. |
| 75 | SHIPING 2" DIA. |
| 76 | SHIPING 2" DIA. |
| 77 | SHIPING 2" DIA. |
| 78 | SHIPING 2" DIA. |
| 79 | SHIPING 2" DIA. |
| 80 | SHIPING 2" DIA. |
| 81 | SHIPING 2" DIA. |
| 82 | SHIPING 2" DIA. |
| 83 | SHIPING 2" DIA. |
| 84 | SHIPING 2" DIA. |
| 85 | SHIPING 2" DIA. |
| 86 | SHIPING 2" DIA. |
| 87 | SHIPING 2" DIA. |
| 88 | SHIPING 2" DIA. |
| 89 | SHIPING 2" DIA. |
| 90 | SHIPING 2" DIA. |
| 91 | SHIPING 2" DIA. |
| 92 | SHIPING 2" DIA. |
| 93 | SHIPING 2" DIA. |
| 94 | SHIPING 2" DIA. |
| 95 | SHIPING 2" DIA. |
| 96 | SHIPING 2" DIA. |
| 97 | SHIPING 2" DIA. |
| 98 | SHIPING 2" DIA. |
| 99 | SHIPING 2" DIA. |
| 100 | SHIPING 2" DIA. |

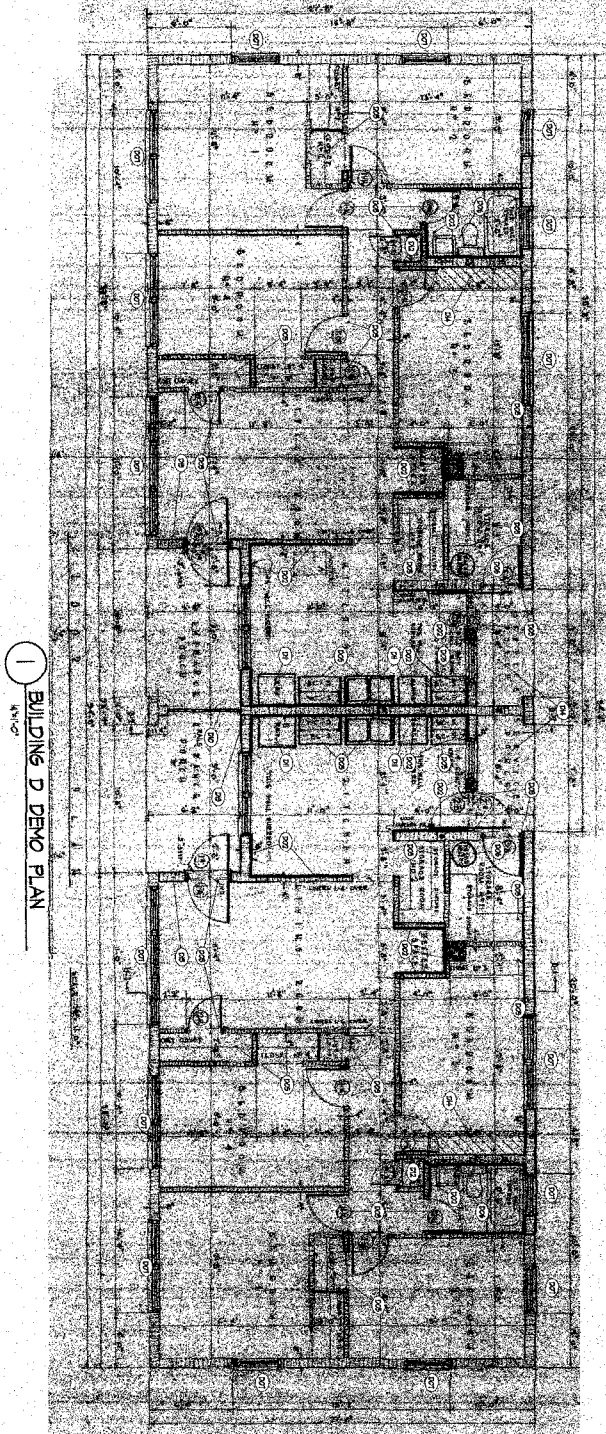

1 BUILDING D DEMO PLAN
A11-0

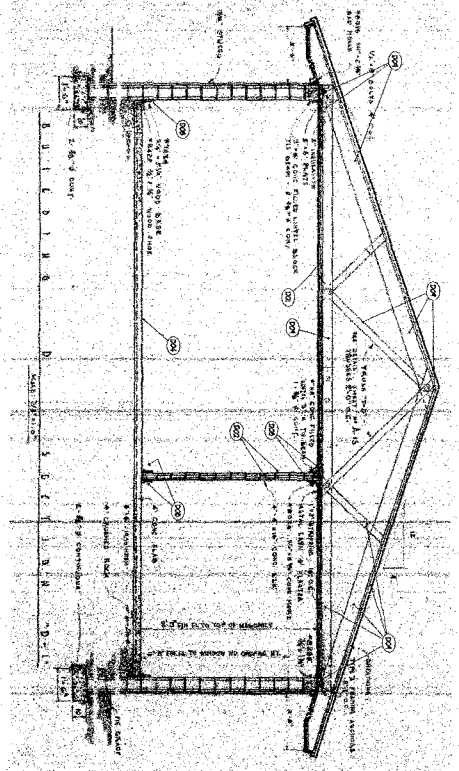

2 TYPICAL DEMOLITION SECTION
A11-0

| GN GENERAL NOTES SCHEDULE | |
|---------------------------|------------------|
| 1 | GENERAL NOTES |
| 2 | DEMOLITION NOTES |
| 3 | DEMOLITION NOTES |
| 4 | DEMOLITION NOTES |
| 5 | DEMOLITION NOTES |
| 6 | DEMOLITION NOTES |
| 7 | DEMOLITION NOTES |
| 8 | DEMOLITION NOTES |
| 9 | DEMOLITION NOTES |
| 10 | DEMOLITION NOTES |
| 11 | DEMOLITION NOTES |
| 12 | DEMOLITION NOTES |
| 13 | DEMOLITION NOTES |
| 14 | DEMOLITION NOTES |
| 15 | DEMOLITION NOTES |
| 16 | DEMOLITION NOTES |
| 17 | DEMOLITION NOTES |
| 18 | DEMOLITION NOTES |
| 19 | DEMOLITION NOTES |
| 20 | DEMOLITION NOTES |
| 21 | DEMOLITION NOTES |
| 22 | DEMOLITION NOTES |
| 23 | DEMOLITION NOTES |
| 24 | DEMOLITION NOTES |
| 25 | DEMOLITION NOTES |
| 26 | DEMOLITION NOTES |
| 27 | DEMOLITION NOTES |
| 28 | DEMOLITION NOTES |
| 29 | DEMOLITION NOTES |
| 30 | DEMOLITION NOTES |
| 31 | DEMOLITION NOTES |
| 32 | DEMOLITION NOTES |
| 33 | DEMOLITION NOTES |
| 34 | DEMOLITION NOTES |
| 35 | DEMOLITION NOTES |
| 36 | DEMOLITION NOTES |
| 37 | DEMOLITION NOTES |
| 38 | DEMOLITION NOTES |
| 39 | DEMOLITION NOTES |
| 40 | DEMOLITION NOTES |
| 41 | DEMOLITION NOTES |
| 42 | DEMOLITION NOTES |
| 43 | DEMOLITION NOTES |
| 44 | DEMOLITION NOTES |
| 45 | DEMOLITION NOTES |
| 46 | DEMOLITION NOTES |
| 47 | DEMOLITION NOTES |
| 48 | DEMOLITION NOTES |
| 49 | DEMOLITION NOTES |
| 50 | DEMOLITION NOTES |

| MARK | DATE | REVISION |
|------|------|----------|
| | | |
| | | |
| | | |
| | | |

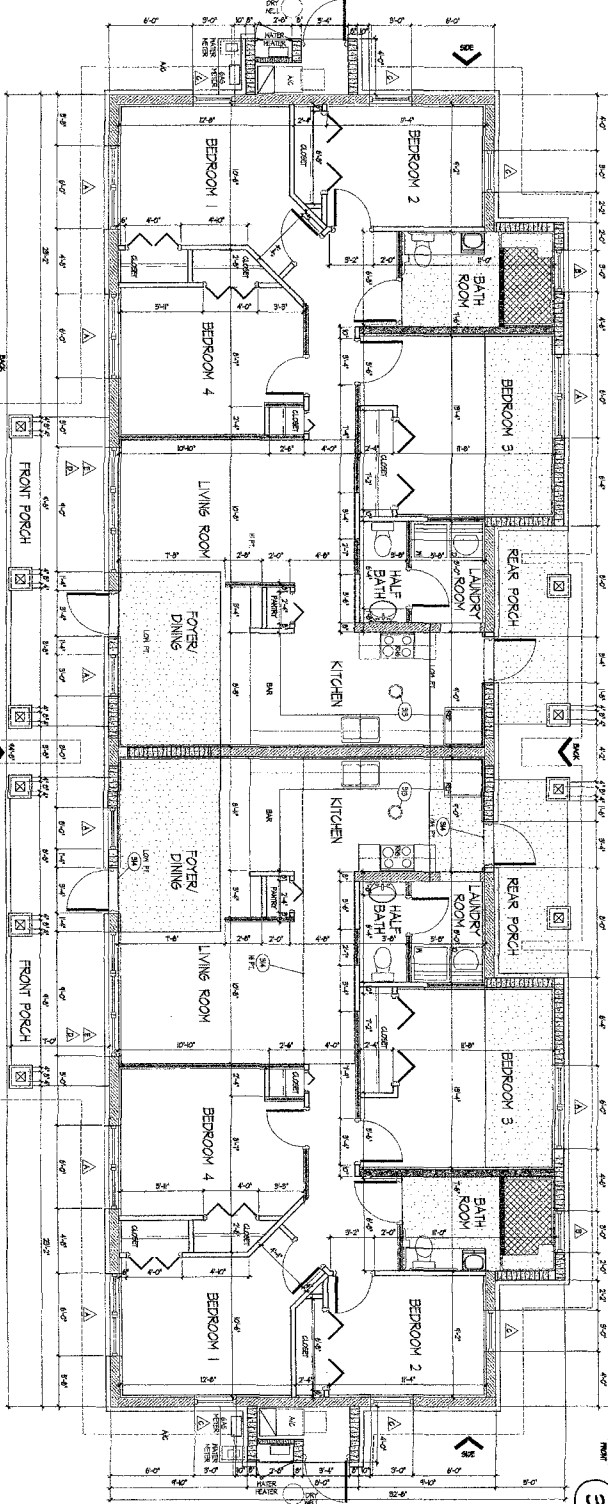
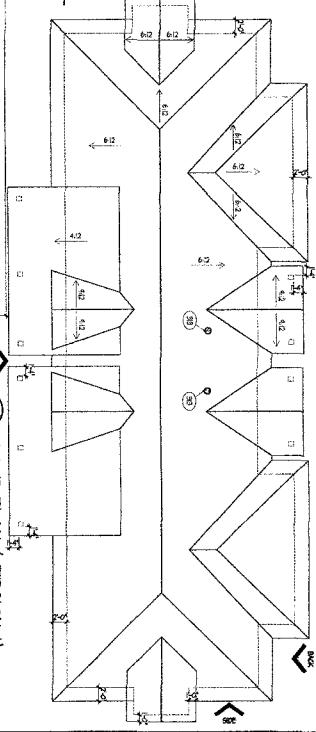
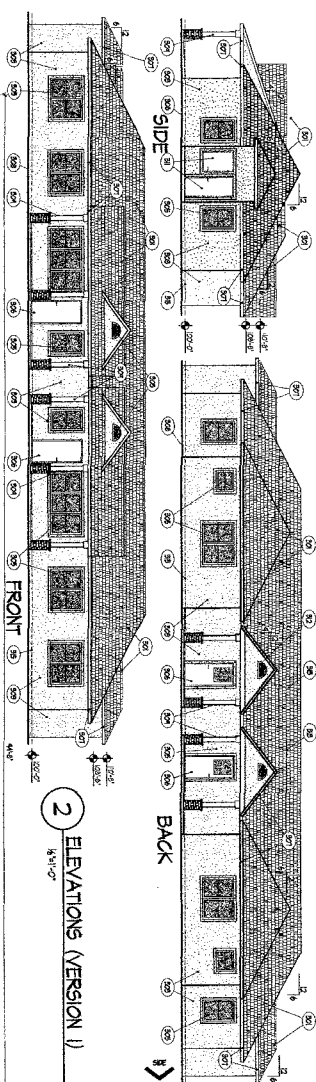

4 ROOF PLAN (VERSION 2)
1/8"=1'-0"

5 ELEVATIONS (VERSION 2)
1/8"=1'-0"

FRONT, BACK, SIDE

MATERIAL SCHEDULE

| NO. | DESCRIPTION |
|-----|---------------------------|
| 01 | EXTERIOR WALLS - CONCRETE |
| 02 | EXTERIOR WALLS - BRICK |
| 03 | EXTERIOR WALLS - STUCCO |
| 04 | EXTERIOR WALLS - CMU |
| 05 | EXTERIOR WALLS - BLOCK |
| 06 | EXTERIOR WALLS - OTHER |
| 07 | EXTERIOR WALLS - OTHER |
| 08 | EXTERIOR WALLS - OTHER |
| 09 | EXTERIOR WALLS - OTHER |
| 10 | EXTERIOR WALLS - OTHER |
| 11 | EXTERIOR WALLS - OTHER |
| 12 | EXTERIOR WALLS - OTHER |
| 13 | EXTERIOR WALLS - OTHER |
| 14 | EXTERIOR WALLS - OTHER |
| 15 | EXTERIOR WALLS - OTHER |
| 16 | EXTERIOR WALLS - OTHER |
| 17 | EXTERIOR WALLS - OTHER |
| 18 | EXTERIOR WALLS - OTHER |
| 19 | EXTERIOR WALLS - OTHER |
| 20 | EXTERIOR WALLS - OTHER |
| 21 | EXTERIOR WALLS - OTHER |
| 22 | EXTERIOR WALLS - OTHER |
| 23 | EXTERIOR WALLS - OTHER |
| 24 | EXTERIOR WALLS - OTHER |
| 25 | EXTERIOR WALLS - OTHER |
| 26 | EXTERIOR WALLS - OTHER |
| 27 | EXTERIOR WALLS - OTHER |
| 28 | EXTERIOR WALLS - OTHER |
| 29 | EXTERIOR WALLS - OTHER |
| 30 | EXTERIOR WALLS - OTHER |
| 31 | EXTERIOR WALLS - OTHER |
| 32 | EXTERIOR WALLS - OTHER |
| 33 | EXTERIOR WALLS - OTHER |
| 34 | EXTERIOR WALLS - OTHER |
| 35 | EXTERIOR WALLS - OTHER |
| 36 | EXTERIOR WALLS - OTHER |
| 37 | EXTERIOR WALLS - OTHER |
| 38 | EXTERIOR WALLS - OTHER |
| 39 | EXTERIOR WALLS - OTHER |
| 40 | EXTERIOR WALLS - OTHER |
| 41 | EXTERIOR WALLS - OTHER |
| 42 | EXTERIOR WALLS - OTHER |
| 43 | EXTERIOR WALLS - OTHER |
| 44 | EXTERIOR WALLS - OTHER |
| 45 | EXTERIOR WALLS - OTHER |
| 46 | EXTERIOR WALLS - OTHER |
| 47 | EXTERIOR WALLS - OTHER |
| 48 | EXTERIOR WALLS - OTHER |
| 49 | EXTERIOR WALLS - OTHER |
| 50 | EXTERIOR WALLS - OTHER |
| 51 | EXTERIOR WALLS - OTHER |
| 52 | EXTERIOR WALLS - OTHER |
| 53 | EXTERIOR WALLS - OTHER |
| 54 | EXTERIOR WALLS - OTHER |
| 55 | EXTERIOR WALLS - OTHER |
| 56 | EXTERIOR WALLS - OTHER |
| 57 | EXTERIOR WALLS - OTHER |
| 58 | EXTERIOR WALLS - OTHER |
| 59 | EXTERIOR WALLS - OTHER |
| 60 | EXTERIOR WALLS - OTHER |
| 61 | EXTERIOR WALLS - OTHER |
| 62 | EXTERIOR WALLS - OTHER |
| 63 | EXTERIOR WALLS - OTHER |
| 64 | EXTERIOR WALLS - OTHER |
| 65 | EXTERIOR WALLS - OTHER |
| 66 | EXTERIOR WALLS - OTHER |
| 67 | EXTERIOR WALLS - OTHER |
| 68 | EXTERIOR WALLS - OTHER |
| 69 | EXTERIOR WALLS - OTHER |
| 70 | EXTERIOR WALLS - OTHER |
| 71 | EXTERIOR WALLS - OTHER |
| 72 | EXTERIOR WALLS - OTHER |
| 73 | EXTERIOR WALLS - OTHER |
| 74 | EXTERIOR WALLS - OTHER |
| 75 | EXTERIOR WALLS - OTHER |
| 76 | EXTERIOR WALLS - OTHER |
| 77 | EXTERIOR WALLS - OTHER |
| 78 | EXTERIOR WALLS - OTHER |
| 79 | EXTERIOR WALLS - OTHER |
| 80 | EXTERIOR WALLS - OTHER |
| 81 | EXTERIOR WALLS - OTHER |
| 82 | EXTERIOR WALLS - OTHER |
| 83 | EXTERIOR WALLS - OTHER |
| 84 | EXTERIOR WALLS - OTHER |
| 85 | EXTERIOR WALLS - OTHER |
| 86 | EXTERIOR WALLS - OTHER |
| 87 | EXTERIOR WALLS - OTHER |
| 88 | EXTERIOR WALLS - OTHER |
| 89 | EXTERIOR WALLS - OTHER |
| 90 | EXTERIOR WALLS - OTHER |
| 91 | EXTERIOR WALLS - OTHER |
| 92 | EXTERIOR WALLS - OTHER |
| 93 | EXTERIOR WALLS - OTHER |
| 94 | EXTERIOR WALLS - OTHER |
| 95 | EXTERIOR WALLS - OTHER |
| 96 | EXTERIOR WALLS - OTHER |
| 97 | EXTERIOR WALLS - OTHER |
| 98 | EXTERIOR WALLS - OTHER |
| 99 | EXTERIOR WALLS - OTHER |
| 100 | EXTERIOR WALLS - OTHER |

